

# N1004937

100CC WHITE PHARMA ROUND HDPE WITH 38-400 NECK FINISH

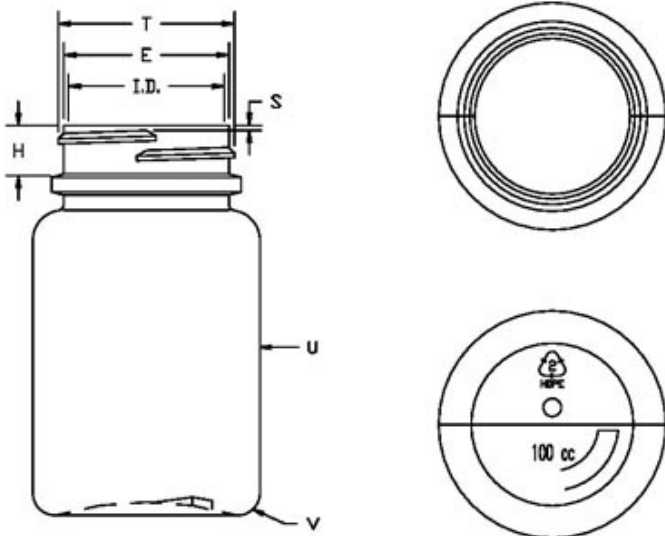

Carton Count  
600

Size  
100.00 CC

Overflow Capacity  
120.00 cc

Neck Diameter  
38.00

Neck Finish  
400

Material  
HDPE

Color  
WHITE

Shape  
ROUND

Item Weight  
13.50 g

Item Height x Width/Diameter  
3.25 in x 1.89 in

Blow Technology  
EXTRUSION

O.BERK® Co. provides a full range of packaging products and services for every aspect of the packaging process from conception and selection of a container and closure, through its decoration and delivery. We can help create broad differentiation through innovative packaging using either stock or designed components.