

N1004930

100CC WHITE PHARMA ROUND HDPE WITH 38-400 NECK FINISH

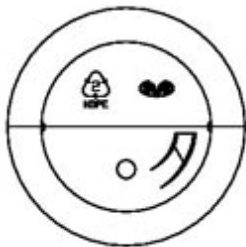
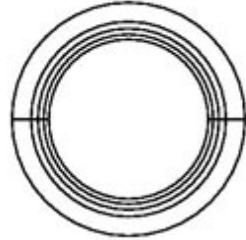
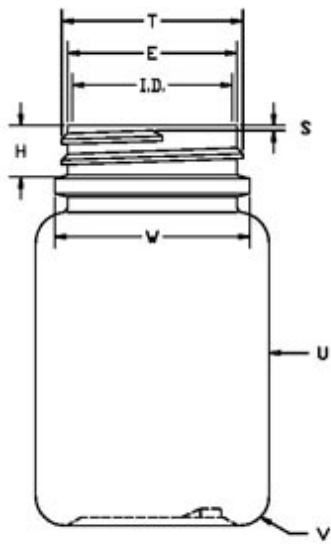

Carton Count
600

Size
100.00 CC

Overflow Capacity
120.00 cc

Neck Diameter
38.00

Neck Finish
400

Material
HDPE

Color
WHITE

Shape
ROUND

Item Weight
11.50 g

Item Height x Width/Diameter
3.25 in x 1.89 in

Blow Technology
EXTRUSION

O.BERK® Co. provides a full range of packaging products and services for every aspect of the packaging process from conception and selection of a container and closure, through its decoration and delivery. We can help create broad differentiation through innovative packaging using either stock or designed components.