

N1004923

200CC WHITE PHARMA ROUND HDPE WITH 38-400 NECK FINISH

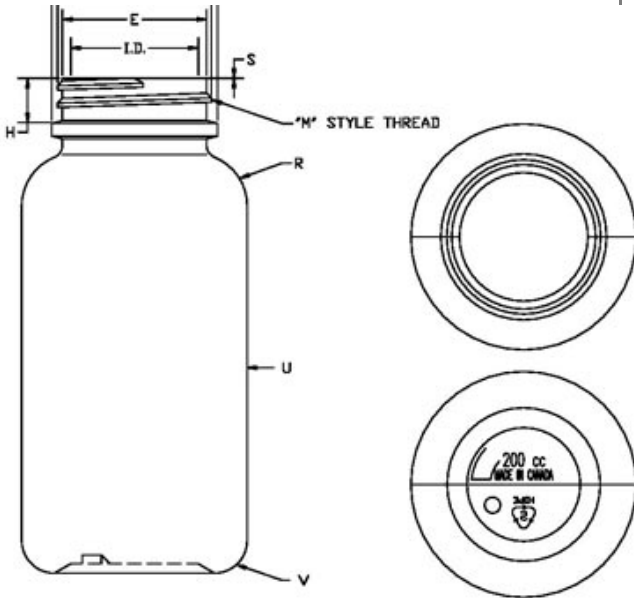

Carton Count
380

Size
200.00 CC

Overflow Capacity
235.00 cc

Neck Diameter
38.00

Neck Finish
400

Material
HDPE

Color
WHITE

Shape
ROUND

Item Weight
17.50 g

Item Height x Width/Diameter
4.75 in x 2.15 in

Blow Technology
EXTRUSION

O.BERK® Co. provides a full range of packaging products and services for every aspect of the packaging process from conception and selection of a container and closure, through its decoration and delivery. We can help create broad differentiation through innovative packaging using either stock or designed components.