

# N1004894

1000CC WHITE PHARMA ROUND HDPE WITH 89-400 NECK FINISH

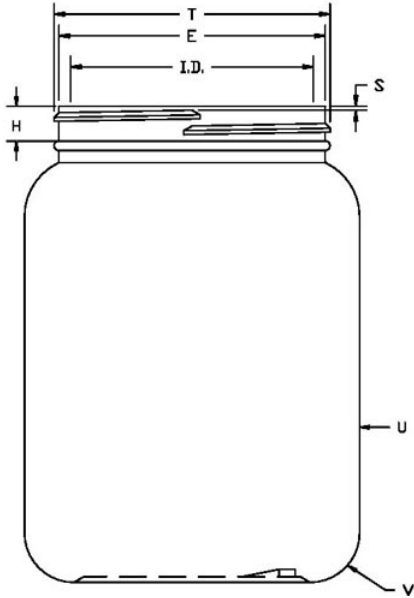

Carton Count  
60

Size  
1000.00 CC

Overflow Capacity  
1220.00 cc

Neck Diameter  
89.00

Neck Finish  
400

Material  
HDPE

Color  
WHITE

Shape  
ROUND

Item Weight  
59.00 g

Item Height x Width/Diameter  
5.85 in x 4.24 in

Blow Technology  
EXTRUSION

O.BERK® Co. provides a full range of packaging products and services for every aspect of the packaging process from conception and selection of a container and closure, through its decoration and delivery. We can help create broad differentiation through innovative packaging using either stock or designed components.