

N1004813

0.5OZ WHITE OVAL LDPE WITH 18-410 NECK FINISH

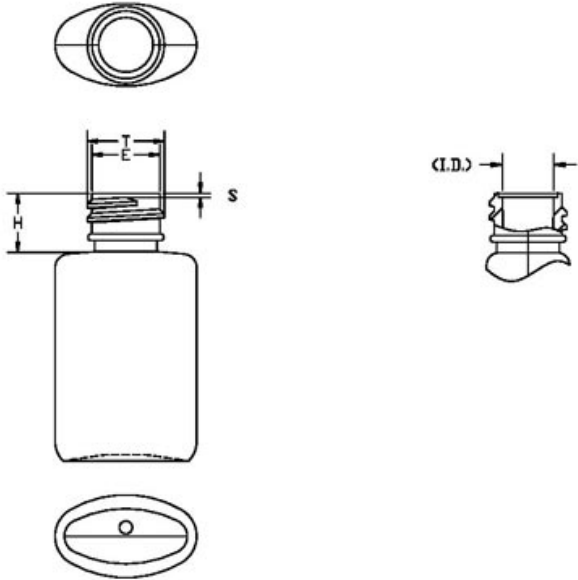

Carton Count
500

Size
0.50 OZ

Overflow Capacity
20.00 cc

Neck Diameter
18.00

Neck Finish
410

Material
LDPE

Color
WHITE

Shape
OVAL

Item Weight
4.00 g

Item Height x Width/Diameter
2.41 in x n/a in

Blow Technology
EXTRUSION

O.BERK® Co. provides a full range of packaging products and services for every aspect of the packaging process from conception and selection of a container and closure, through its decoration and delivery. We can help create broad differentiation through innovative packaging using either stock or designed components.