

# N1004786

50ML WHITE OVAL HDPE WITH 20-410 NECK FINISH

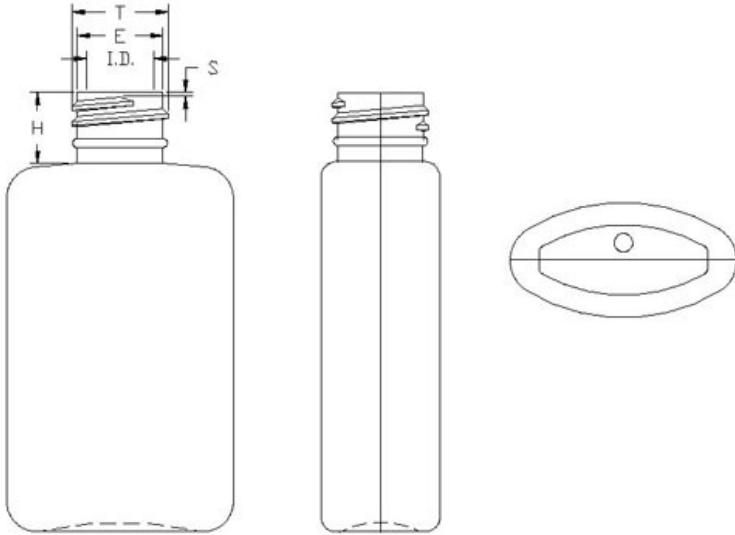

Carton Count  
950

Size  
50.00 ML

Overflow Capacity  
60.00 cc

Neck Diameter  
20.00

Neck Finish  
410

Material  
HDPE

Color  
WHITE

Shape  
OVAL

Item Weight  
10.00 g

Item Height x Width/Diameter  
3.55 in x n/a in

Blow Technology  
EXTRUSION

O.BERK® Co. provides a full range of packaging products and services for every aspect of the packaging process from conception and selection of a container and closure, through its decoration and delivery. We can help create broad differentiation through innovative packaging using either stock or designed components.