

N1004757

500ML WHITE ROUND HDPE WITH 89-400 NECK FINISH

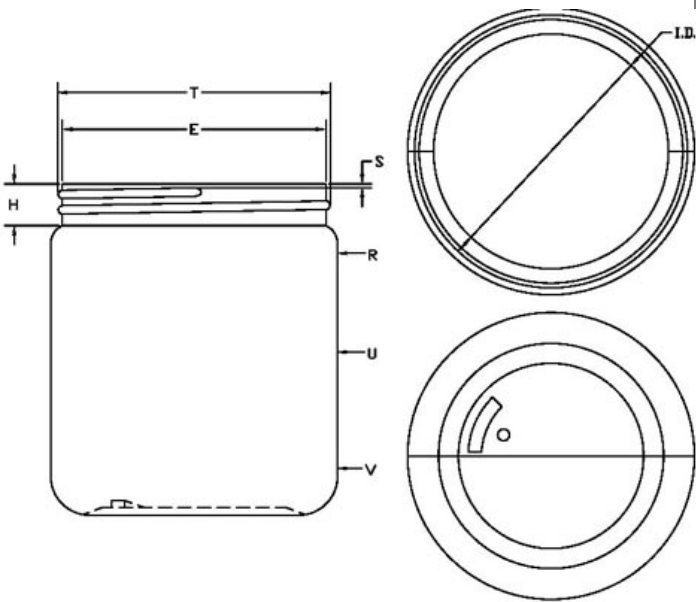

Carton Count
120

Size
500.00 ML

Overflow Capacity
650.00 cc

Neck Diameter
89.00

Neck Finish
400

Material
HDPE

Color
WHITE

Shape
ROUND

Item Weight
35.00 g

Item Height x Width/Diameter
4.24 in x 3.61 in

Blow Technology
EXTRUSION

O.BERK® Co. provides a full range of packaging products and services for every aspect of the packaging process from conception and selection of a container and closure, through its decoration and delivery. We can help create broad differentiation through innovative packaging using either stock or designed components.