

N1004694

20CC WHITE PHARMA ROUND HDPE WITH 28-400 NECK FINISH

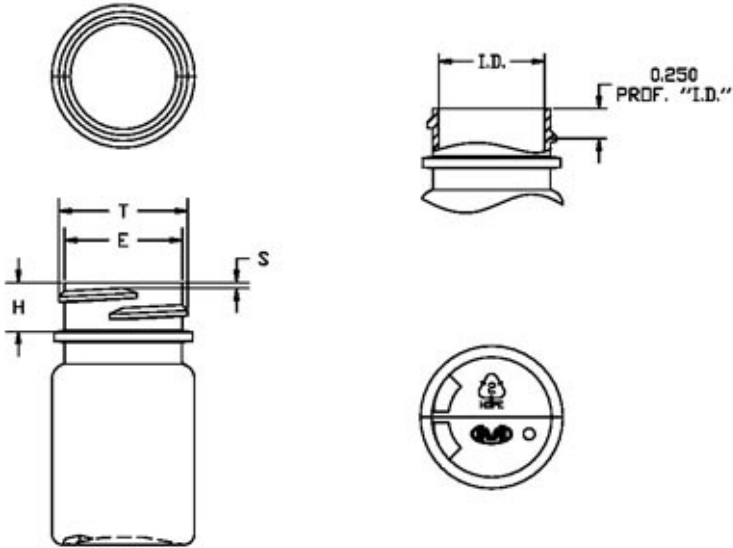

Carton Count
2200

Size
20.00 CC

Overflow Capacity
30.00 cc

Neck Diameter
28.00

Neck Finish
400

Material
HDPE

Color
WHITE

Shape
ROUND

Item Weight
5.80 g

Item Height x Width/Diameter
2.19 in x 1.19 in

Blow Technology
EXTRUSION

O.BERK® Co. provides a full range of packaging products and services for every aspect of the packaging process from conception and selection of a container and closure, through its decoration and delivery. We can help create broad differentiation through innovative packaging using either stock or designed components.