

N1004601

350ML WHITE CYLINDER HDPE WITH 28-400 NECK FINISH

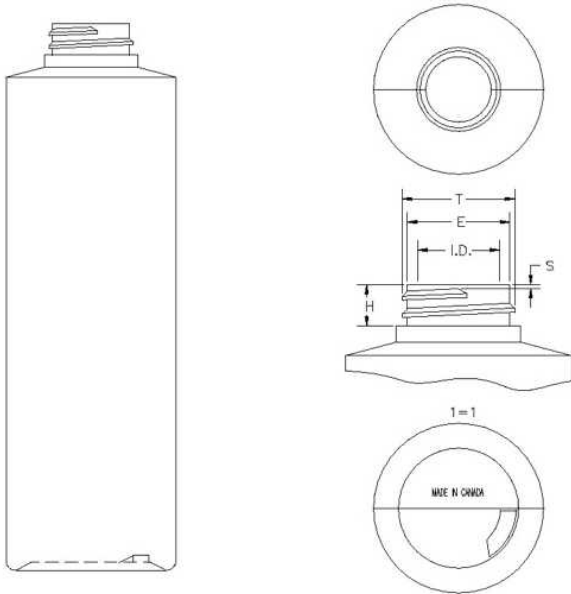

Carton Count
226

Size
350.00 ML

Overflow Capacity
364.00 cc

Neck Diameter
28.00

Neck Finish
400

Material
HDPE

Color
WHITE

Shape
CYLINDER

Item Weight
37.50 g

Item Height x Width/Diameter
7.06 in x 2.18 in

Blow Technology
EXTRUSION

O.BERK® Co. provides a full range of packaging products and services for every aspect of the packaging process from conception and selection of a container and closure, through its decoration and delivery. We can help create broad differentiation through innovative packaging using either stock or designed components.