

N1004594

1OZ WHITE CYLINDER LDPE WITH 20-410 NECK FINISH

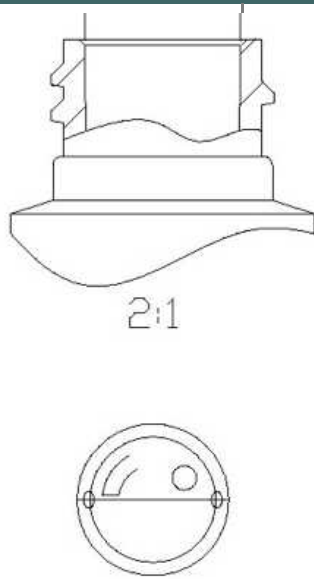
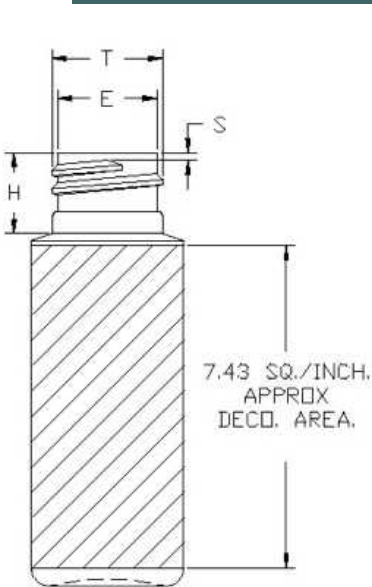

Carton Count
1500

OZ

Flow Capacity

0 cc

Ø Diameter

0

Ø Finish

Material

PE

Blow

TE

Shape

CYLINDER

Item Weight

6.00 g

Item Height x Width/Diameter

3.06 in x 1.085 in

Blow Technology

EXTRUSION

O.BERK® Co. provides a full range of packaging products and services for every aspect of the packaging process from conception and selection of a container and closure, through its decoration and delivery. We can help create broad differentiation through innovative packaging using either stock or designed components.