

# N1004580

80ML WHITE CYLINDER HDPE WITH 20-415 NECK FINISH

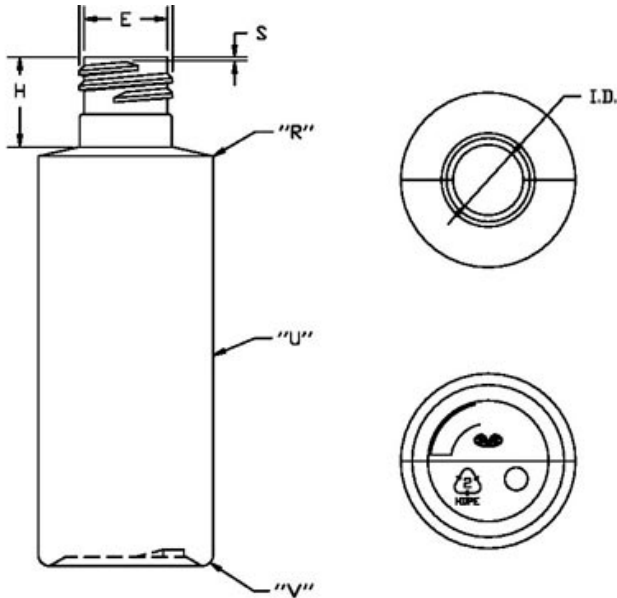

Carton Count  
700

Size  
80.00 ML

Overflow Capacity  
89.00 cc

Neck Diameter  
20.00

Neck Finish  
415

Material  
HDPE

Color  
WHITE

Shape  
CYLINDER

Item Weight  
11.00 g

Item Height x Width/Diameter  
4.251 in x 1.47 in

Blow Technology  
EXTRUSION

O.BERK® Co. provides a full range of packaging products and services for every aspect of the packaging process from conception and selection of a container and closure, through its decoration and delivery. We can help create broad differentiation through innovative packaging using either stock or designed components.