

N1004576

75ML WHITE CYLINDER HDPE WITH 20-415 NECK FINISH

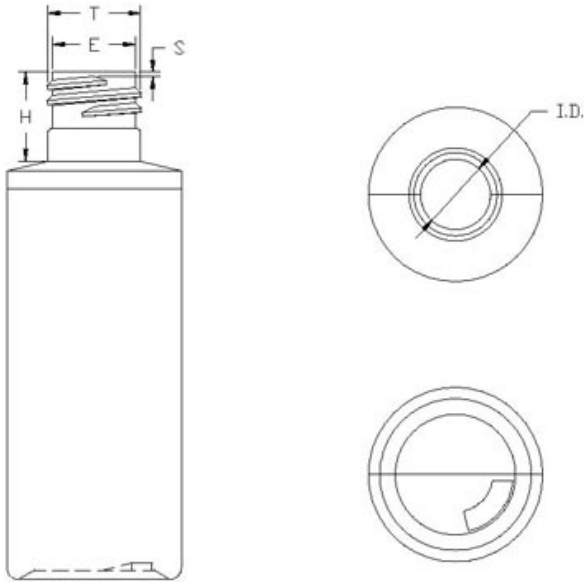

Carton Count
700

Size
75.00 ML

Overflow Capacity
89.00 cc

Neck Diameter
20.00

Neck Finish
415

Material
HDPE

Color
WHITE

Shape
CYLINDER

Item Weight
9.00 g

Item Height x Width/Diameter
4.251 in x 1.47 in

Blow Technology
EXTRUSION

O.BERK® Co. provides a full range of packaging products and services for every aspect of the packaging process from conception and selection of a container and closure, through its decoration and delivery. We can help create broad differentiation through innovative packaging using either stock or designed components.