

# N1004563

350ML WHITE CYLINDER HDPE WITH 28-400 NECK FINISH

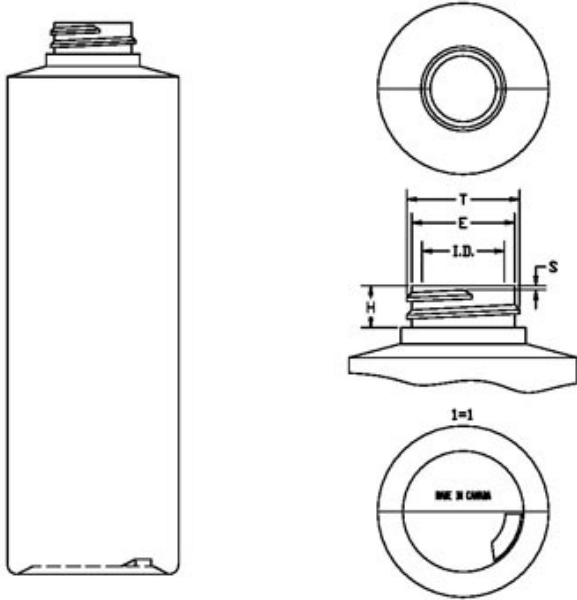

Carton Count  
226

Size  
350.00 ML

Overflow Capacity  
375.00 cc

Neck Diameter  
28.00

Neck Finish  
400

Material  
HDPE

Color  
WHITE

Shape  
CYLINDER

Item Weight  
26.00 g

Item Height x Width/Diameter  
7.06 in x 2.18 in

Blow Technology  
EXTRUSION

O.BERK® Co. provides a full range of packaging products and services for every aspect of the packaging process from conception and selection of a container and closure, through its decoration and delivery. We can help create broad differentiation through innovative packaging using either stock or designed components.