

# N1004551

## 4OZ WHITE CYLINDER HDPE WITH 20-410 NECK FINISH

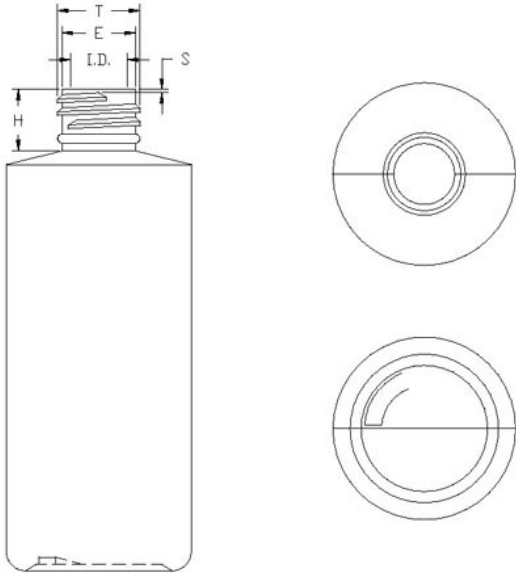

Carton Count  
648

Size  
4.00 OZ

Overflow Capacity  
135.00 cc

Neck Diameter  
20.00

Neck Finish  
410

Material  
HDPE

Color  
WHITE

Shape  
CYLINDER

Item Weight  
12.00 g

Item Height x Width/Diameter  
4.465 in x 1.725 in

Blow Technology  
EXTRUSION

O.BERK® Co. provides a full range of packaging products and services for every aspect of the packaging process from conception and selection of a container and closure, through its decoration and delivery. We can help create broad differentiation through innovative packaging using either stock or designed components.