

N1004538

4OZ WHITE CYLINDER HDPE WITH 22-415 NECK FINISH

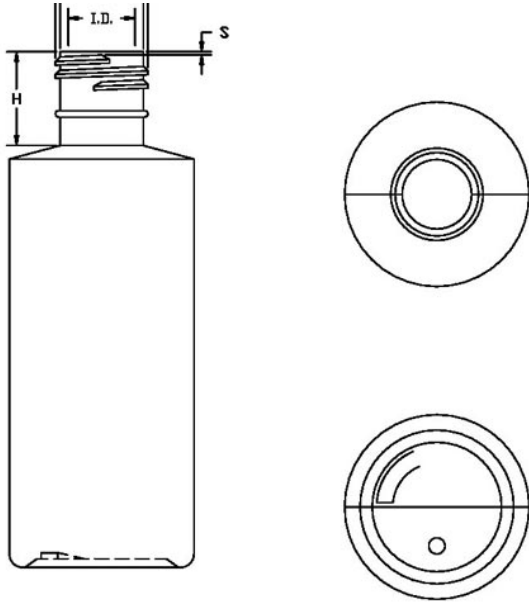

Carton Count
500

Size
4.00 OZ

Overflow Capacity
140.00 cc

Neck Diameter
22.00

Neck Finish
415

Material
HDPE

Color
WHITE

Shape
CYLINDER

Item Weight
12.00 g

Item Height x Width/Diameter
4.78 in x 1.7 in

Blow Technology
EXTRUSION

O.BERK® Co. provides a full range of packaging products and services for every aspect of the packaging process from conception and selection of a container and closure, through its decoration and delivery. We can help create broad differentiation through innovative packaging using either stock or designed components.