

# N1004535

## 6OZ WHITE CYLINDER HDPE WITH 24-410 NECK FINISH

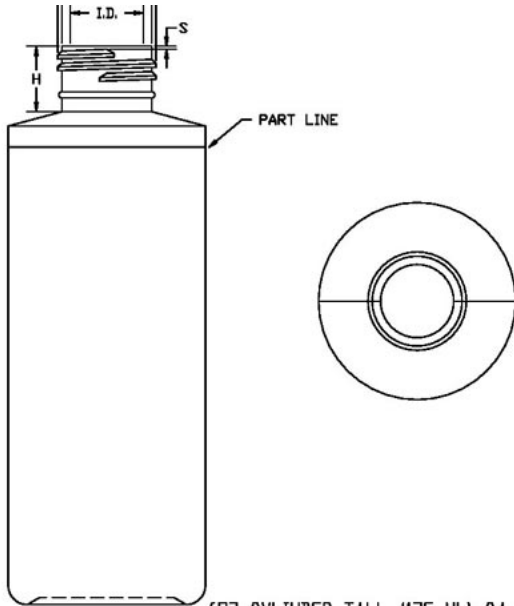

Carton Count  
400

Size  
6.00 OZ

Overflow Capacity  
200.00 cc

Neck Diameter  
24.00

Neck Finish  
410

Material  
HDPE

Color  
WHITE

Shape  
CYLINDER

Item Weight  
17.00 g

Item Height x Width/Diameter  
5.275 in x 1.9 in

Blow Technology  
EXTRUSION

O.BERK® Co. provides a full range of packaging products and services for every aspect of the packaging process from conception and selection of a container and closure, through its decoration and delivery. We can help create broad differentiation through innovative packaging using either stock or designed components.