

N1004448

4OZ WHITE BOSTON ROUND LDPE WITH 20-410 NECK FINISH

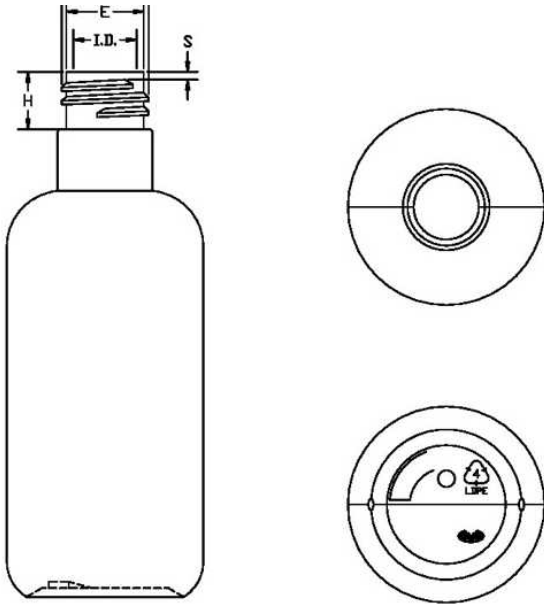

Carton Count
400

Size
4.00 OZ

Overflow Capacity
140.00 cc

Neck Diameter
20.00

Neck Finish
410

Material
LDPE

Color
WHITE

Shape
BOSTON ROUND

Item Weight
10.00 g

Item Height x Width/Diameter
4.768 in x 1.775 in

Blow Technology
EXTRUSION

O.BERK® Co. provides a full range of packaging products and services for every aspect of the packaging process from conception and selection of a container and closure, through its decoration and delivery. We can help create broad differentiation through innovative packaging using either stock or designed components.