

N1004441

300ML WHITE BOSTON ROUND HDPE WITH 24-415 NECK FINISH

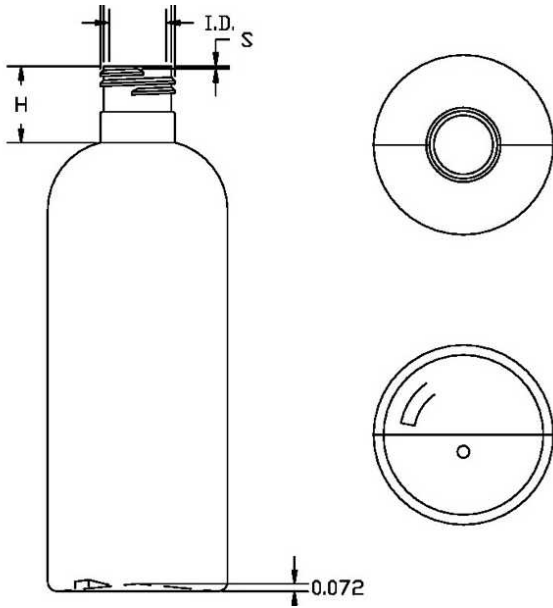

Carton Count
270

Size
300.00 ML

Overflow Capacity
345.00 cc

Neck Diameter
24.00

Neck Finish
415

Material
HDPE

Color
WHITE

Shape
BOSTON ROUND

Item Weight
22.00 g

Item Height x Width/Diameter
6.6 in x 2.265 in

Blow Technology
EXTRUSION

O.BERK® Co. provides a full range of packaging products and services for every aspect of the packaging process from conception and selection of a container and closure, through its decoration and delivery. We can help create broad differentiation through innovative packaging using either stock or designed components.