

N1004401

6OZ WHITE BOSTON ROUND HDPE WITH 24-410 NECK FINISH

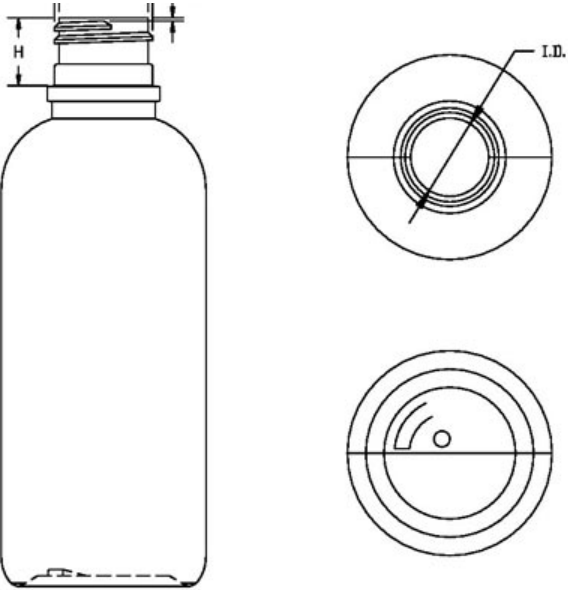

Carton Count
381

Size
6.00 OZ

Overflow Capacity
206.00 cc

Neck Diameter
24.00

Neck Finish
410

Material
HDPE

Color
WHITE

Shape
BOSTON ROUND

Item Weight
16.00 g

Item Height x Width/Diameter
5.48 in x 1.95 in

Blow Technology
EXTRUSION

O.BERK® Co. provides a full range of packaging products and services for every aspect of the packaging process from conception and selection of a container and closure, through its decoration and delivery. We can help create broad differentiation through innovative packaging using either stock or designed components.