

N1004356

8OZ WHITE BOSTON ROUND HDPE WITH 24-410 NECK FINISH

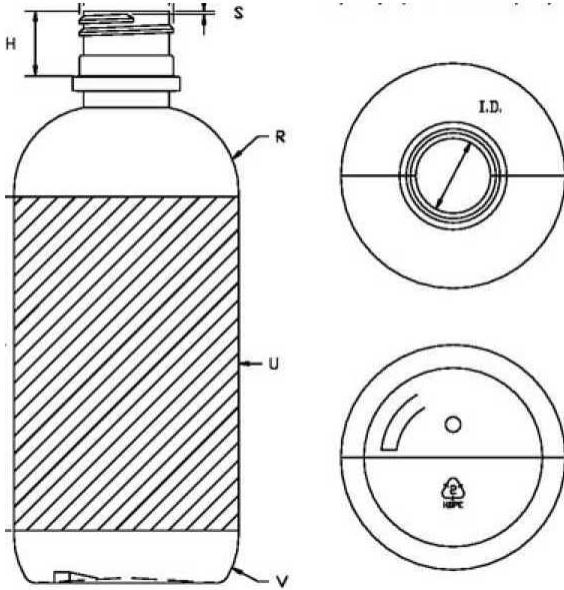

Carton Count
300

Size
8.00 OZ

Overflow Capacity
278.00 cc

Neck Diameter
24.00

Neck Finish
410

Material
HDPE

Color
WHITE

Shape
BOSTON ROUND

Item Weight
19.00 g

Item Height x Width/Diameter
5.74 in x 2.24 in

Blow Technology
EXTRUSION

O.BERK® Co. provides a full range of packaging products and services for every aspect of the packaging process from conception and selection of a container and closure, through its decoration and delivery. We can help create broad differentiation through innovative packaging using either stock or designed components.