

# N1004347

## 2OZ WHITE BOSTON ROUND HDPE WITH 18-415 NECK FINISH

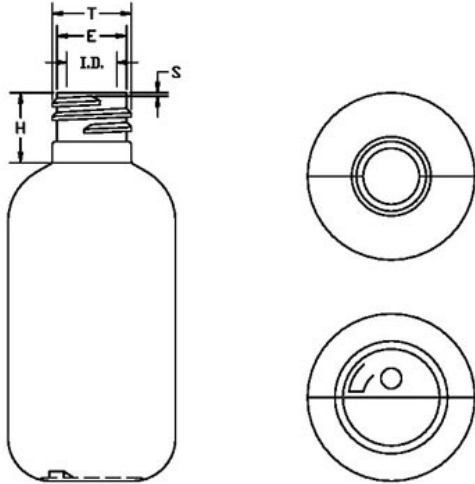

Carton Count  
1000

Size  
2.00 OZ

Overflow Capacity  
65.00 cc

Neck Diameter  
18.00

Neck Finish  
415

Material  
HDPE

Color  
WHITE

Shape  
BOSTON ROUND

Item Weight  
8.00 g

Item Height x Width/Diameter  
3.412 in x 1.47 in

Blow Technology  
EXTRUSION

O.BERK® Co. provides a full range of packaging products and services for every aspect of the packaging process from conception and selection of a container and closure, through its decoration and delivery. We can help create broad differentiation through innovative packaging using either stock or designed components.