

N1004336

1OZ WHITE BOSTON ROUND HDPE WITH 20-410 NECK FINISH

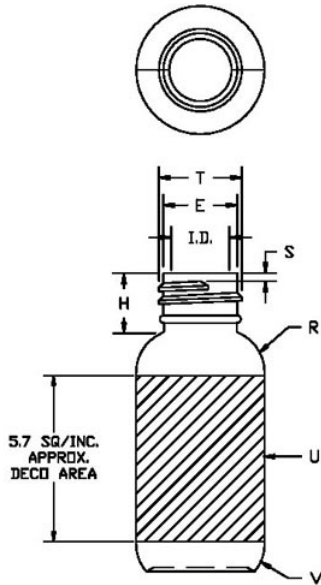

Carton Count
1600

Size
1.00 OZ

Overflow Capacity
36.00 cc

Neck Diameter
20.00

Neck Finish
410

Material
HDPE

Color
WHITE

Shape
BOSTON ROUND

Item Weight
6.00 g

Item Height x Width/Diameter
2.793 in x 1.2 in

Blow Technology
EXTRUSION

O.BERK® Co. provides a full range of packaging products and services for every aspect of the packaging process from conception and selection of a container and closure, through its decoration and delivery. We can help create broad differentiation through innovative packaging using either stock or designed components.